

# SOME TYPICAL EXTRUSION DIMENSIONS

## L shape

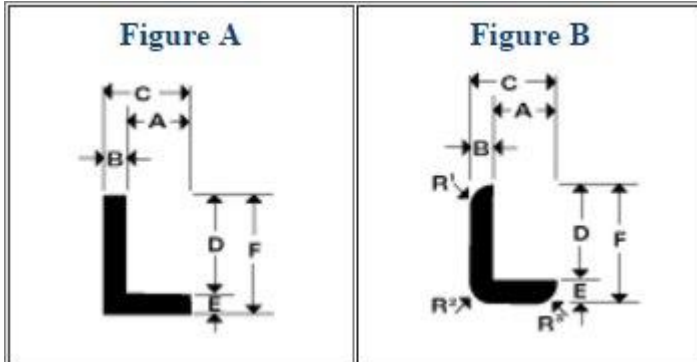

## Bulb seal

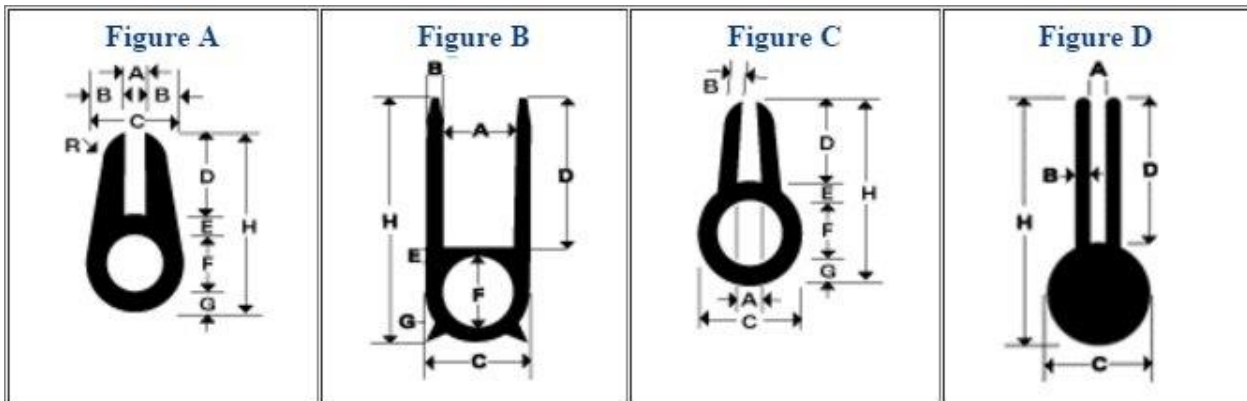

## H channel

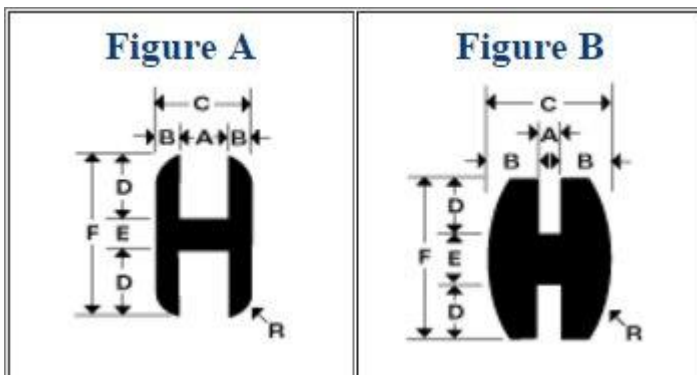

## E seal

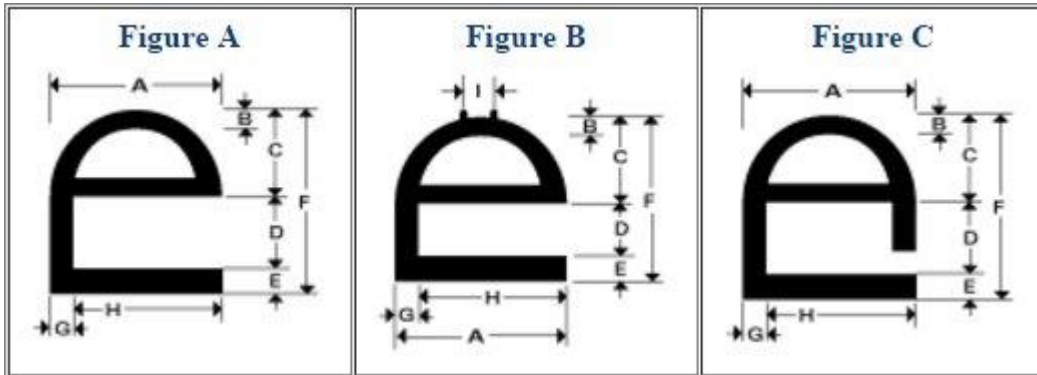

## Bumper

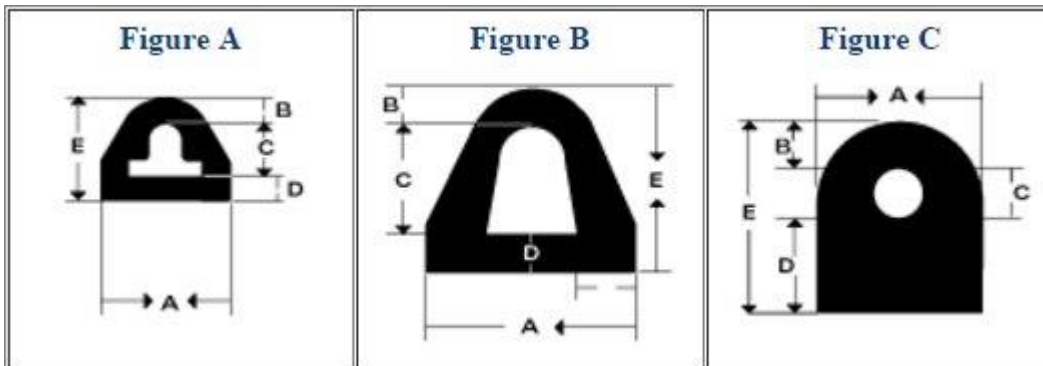

## Wing bumper

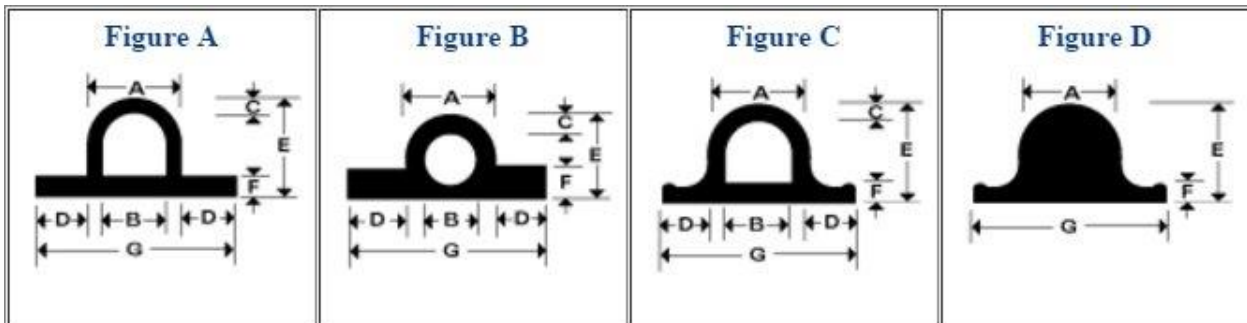

# T shape

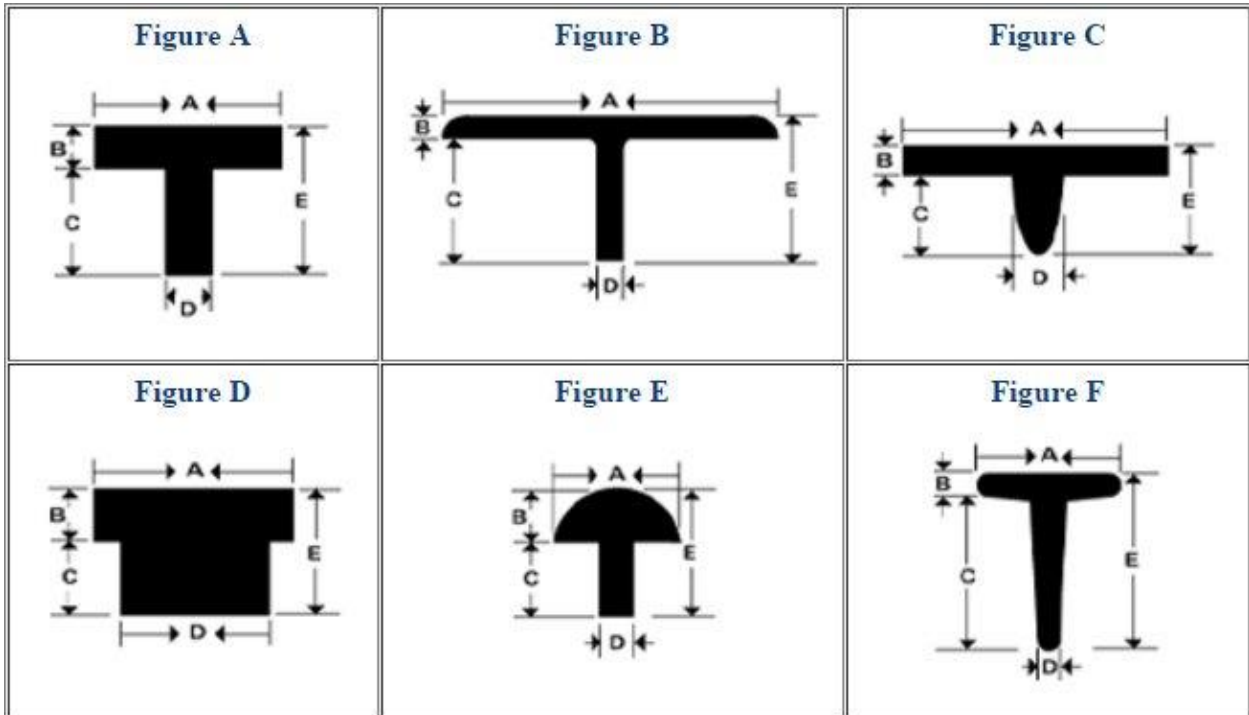

# D seal

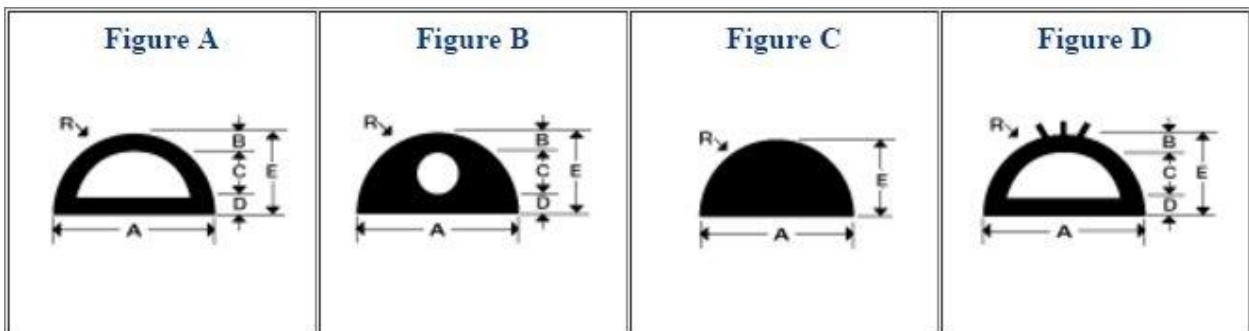

# P seal

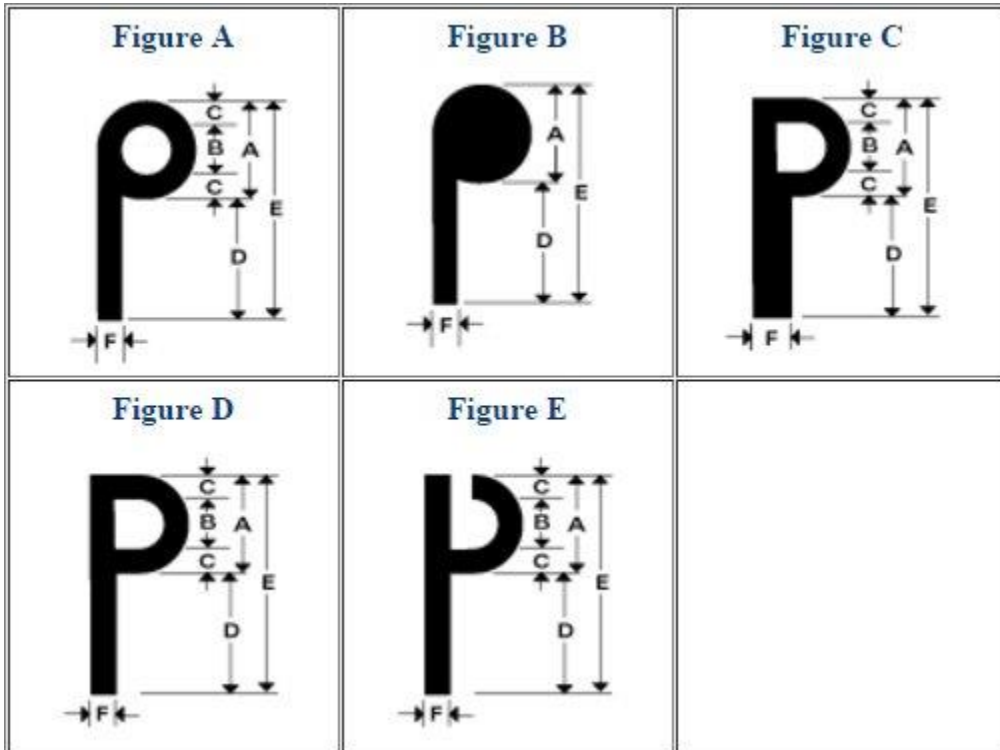

# U channel

